

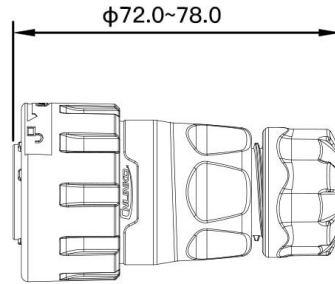

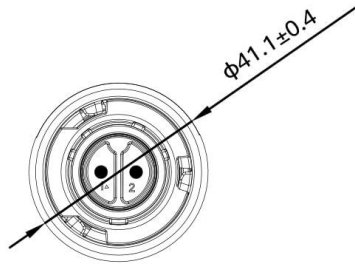

Standard Size







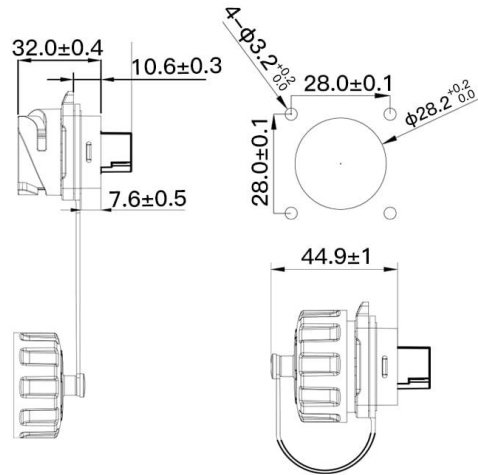
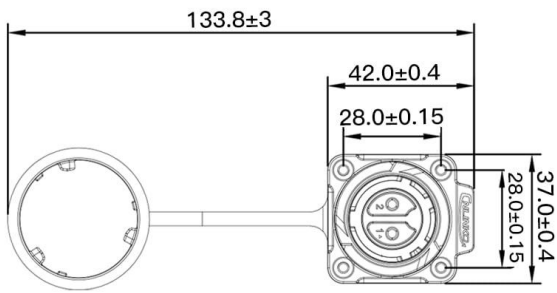

Plastic & Metal Plug



Four-Hole Socket



Connector Specifications

Product Map (Male)					
Product Map (Female)					
Number of Pins	2Pin	3Pin	4Pin	10Pin	12Pin
Rated Current	35A		25A	10A	
Working Voltage	300V AC		500V AC	500V AC	
Withstanding Voltage	1500V AC		2000V AC	2000V AC	
Contact Resistance Max	1mΩ		1mΩ	3mΩ	
Insulation Resistance Min	500MΩ		500MΩ	500MΩ	
Contact Diameter x Number	φ3.0*2	φ3.0*3	φ3.0*4	φ1.5*10	φ1.5*12
Wire Gauge	6.0~8.0mm ² /10~8AWG		2.5~4.0mm ² / 14~12AWG	1.0~1.5mm ² /18~16AWG	
Cable O.D Range	φ10.5-φ13.2mm			φ7-φ10.5mm	
Connection Method	Soldering/Screwing		Soldering		
Protection Level	IP68(mated,2m/48h)				
Mechanical Life	Over 2000 Times				
Operating Temperature	-25°C ~ +85°C				
Salt Spray	≥48H				
Certifications	TUV, UL,CE, RoHS				