

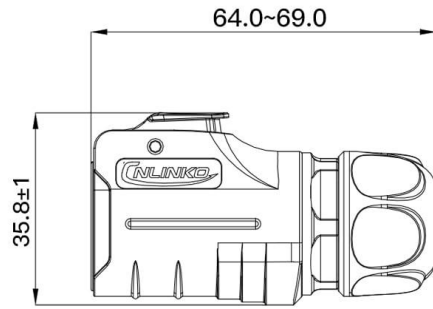

Standard Size

unit:mm

Plug

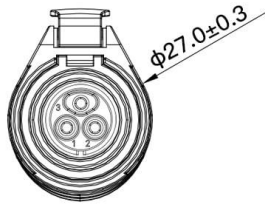



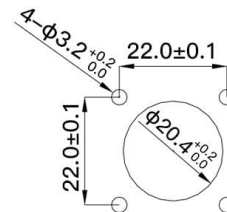
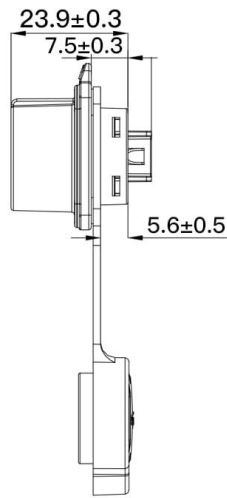
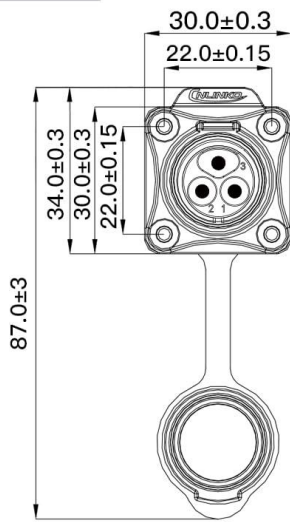



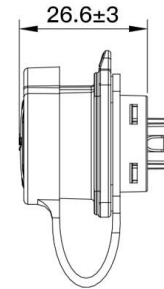









Socket



Mounting hole size
Mounting screw size



Connector Specifications

Male Plug								
Female Socket								
Number of Pins	2pin	3pin	4pin	5pin	7pin	9pin	12pin	14pin
Rated Current	20A			10A		5A		
Working Voltage	500V AC					250V AC		
Withstanding Voltage	2000V AC					1500V AC		
Contact Resistance Max	1.0mΩ			3.0mΩ		5mΩ		
Insulation Resistance Min	500MΩ							
Contact Diameter x Number	φ2.7*2	φ2.7*3	φ2.7*4	φ1.8*5	φ1.8*7	φ1.0*9	φ1.0*12	φ1.0*14
Wire Gauge	2.5~4.0mm ² /14~12AWG			1.0~1.5mm ² /18~16AWG		0.34~0.5mm ² /22~20AWG		
Cable O.D Range	Φ10.0~12.0mm					Φ5.0~Φ6.5mm		Φ10.0~Φ12.0mm
Connection Method	Soldering							
Protection Level	IP68 (mated,2m/48h)							
Mechanical Life	2000 Times							
Operating Temperature	-40°C ~ 120°C							
Salt Spray	≥48H							
Certifications	TUV, UL,CE, RoHS							