

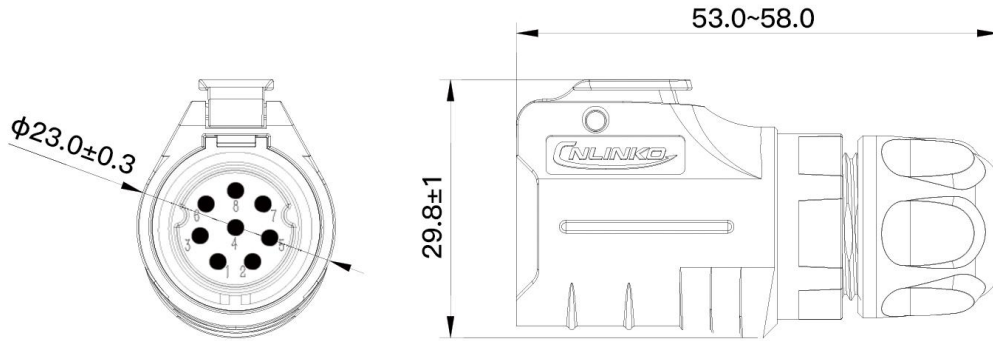

# Standard Size

Plug







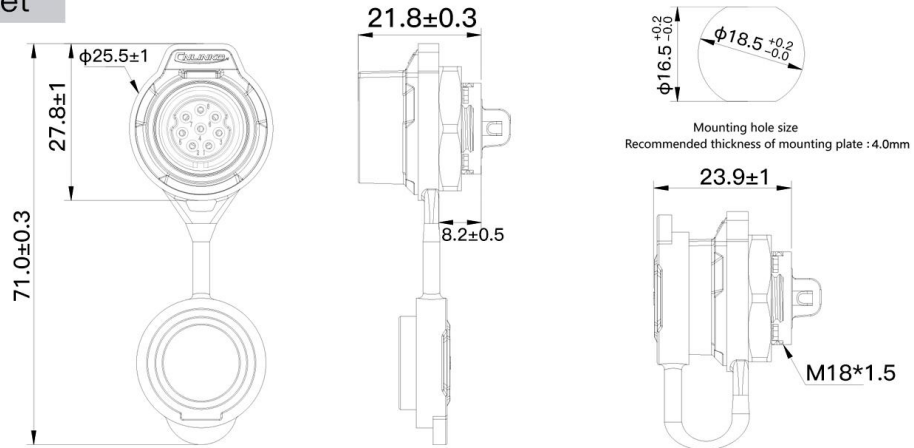







Unit:mm



Socket



# Connector Specifications

Product Map (Male)							
Product Map (Female)							
Number of Pins	<b>2pin</b>	<b>3pin</b>	<b>4pin</b>	<b>5pin</b>	<b>7pin</b>	<b>8pin</b>	<b>9pin</b>
Rated Current	<b>10A</b>			<b>5A</b>			
Working Voltage	<b>400V AC</b>			<b>250V AC</b>			
Withstanding Voltage	<b>2000V AC</b>			<b>1500V AC</b>			
Contact Resistance Max	<b>3mΩ</b>			<b>5mΩ</b>			
Insulation Resistance Min	<b>500MΩ</b>			<b>500MΩ</b>			
Contact Diameter x Number	<b>φ1.5*2</b>	<b>φ1.5*3</b>	<b>φ1.5*4</b>	<b>φ1.0*5</b>	<b>φ1.0*7</b>	<b>φ1.0*8</b>	<b>φ1.0*9</b>
Wire Gauge	<b>1.0~1.5mm<sup>2</sup>/18~16AWG</b>			<b>0.34~0.5mm<sup>2</sup>/22~20AWG</b>			
Cable O.D Range	<b>φ7.0-φ9.0mm</b>			<b>φ5.0-7.0mm</b>			
Connection Method	<b>Soldering</b>						
Protection Level	<b>IP68 (2m/48h)</b>						
Mechanical Life	<b>Over 2000 Times</b>						
Operating Temperature	<b>-40°C ~ +120°C</b>						
Salt Spray	<b>≥48H</b>						
Certifications	<b>TUV, UL,CE, RoHS</b>						